

# DURAMOV® Plastic Cable Carriers

DURAMOV® 塑料电缆拖链

## C11 易填充微型电缆拖链

### Micro cable carriers, open design and cable filled quickly

C11易填充微型电缆拖链体积小，基于一片式开口设计重量轻且便于快速填充电缆，同样适用于高速运动。C11微型电缆拖链适用于较小安装空间，多种尺寸规格可选。

C11 micro cable carriers are very small, one piece and open design carriers with low weight, making them ideal for highly dynamic applications and cables filled quickly. C11 micro cable carriers are optimal for the smallest installation spaces, and are available in many versions.



开口设计，易填充电缆  
Open design, easy to fill cables



阻燃等级 Flammability Class  
UL94 V2



符合CE 标准 certification



RoHS认证 certification



低噪音 Low-noise



根据需求提供ESD抗静电荷/防爆版拖链C11E  
Electrically conductive ESD/ATEX version C11E upon request

内高05-10mm，内宽05-20mm  
Inner height from 5mm to 10mm,  
Inner width from 5mm to 20mm

一片式开口设计，易填充电缆  
One-piece and open design  
Very easy to fill cables

小节距设计实现低噪音  
顺畅运行  
Small pitch for low-noise  
Smooth running

可选带梳妆板接头  
With tiwrap plates  
are available

极小转弯半径  
Smallest bend radius

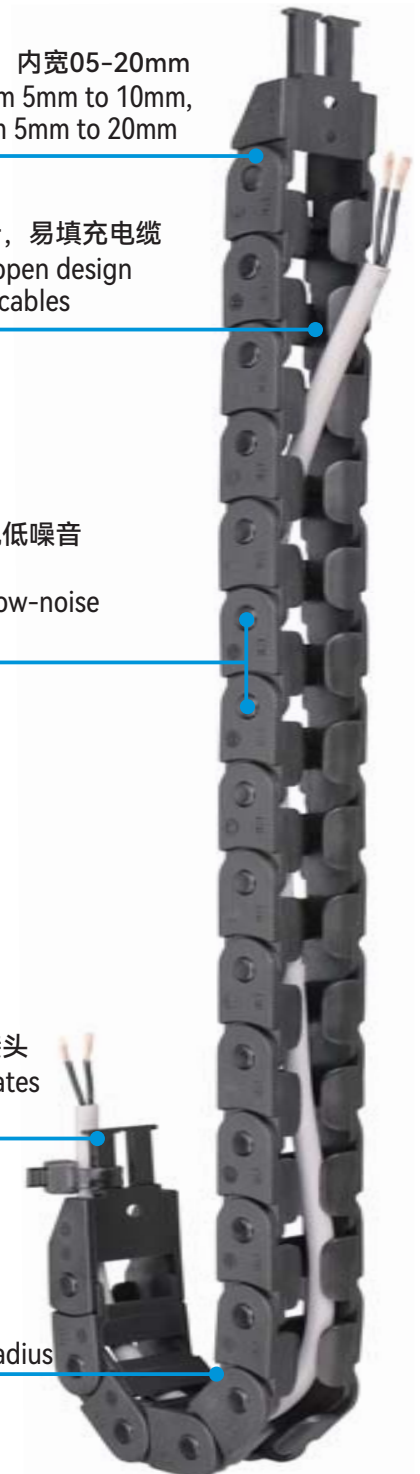



C11

DURAMOV®

www.csb-ep.com  
sales@csb-ep.com

电话: 0573 84186133/84185527  
Tel: 0086 573 84187009

## 标准尺寸 Standard dimensions

易填充微型电缆拖链 Micro cable carriers, open design and cable filled quickly	产品编码 Part No.	内宽 Bi	外宽 Ba	内高 Hi	外高 Ha	弯曲半径 R	架空长度	页码
		Inner width [mm]	Outer width [mm]	Inner height [mm]	Outer height [mm]	Bend radius [mm]	Unsupported length [m]	Page
	C11.05	5-10	8.7-13.7	5	8	10-18	≤0.3	P32
	C11.07	7-30	12-35	7	10	15-48	≤0.5	P34
	C11.10	10-20	16.5-26.5	10	15	18-38	≤0.5	P36

## 安装说明 Installation



扭转并卡合  
Twist and click



压装电缆  
Press in cable

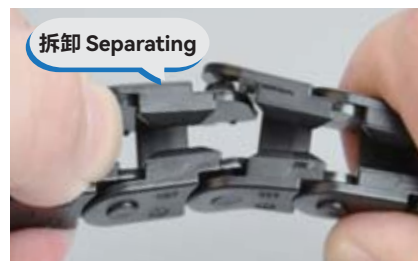

拆卸并分开  
Twist and divide

## 典型适用行业和应用 Typical Applicable Industries and Applications

- 通用机械
- 洁净室应用
- 电子设备
- 办公设备
- 自动售货机
- 测量设备
- 包装机
- 医疗行业
- General machinery
- Cleanroom applications
- Electronic apparatus
- Office equipment
- Vending machines
- Measuring equipment
- Packaging machines
- Medical industries

# DURAMOV® Plastic Cable Carriers

## DURAMOV® 塑料电缆拖链

### C11.05 易填充微型电缆拖链 Micro cable carriers, open design and cable filled quickly



#### 标准尺寸 Standard dimensions

产品编码 Part No.	内宽 Bi	外宽 Ba	内高 Hi	外高 Ha	弯曲半径 R	重量			
	Inner width [mm]	Outer width [mm]	Inner height [mm]	Outer height [mm]		Bend radius [mm]	Weight [kg/m]		
C11.05.05	5	8.7	5	8	010	012	015	018	0.03
C11.05.07	7	10	5	8	010	012	015	018	0.04
C11.05.10	10	13.7	5	8	010	012	015	018	0.05

\*根据要求提供 Available upon request

#### 安装尺寸 Installation dimensions

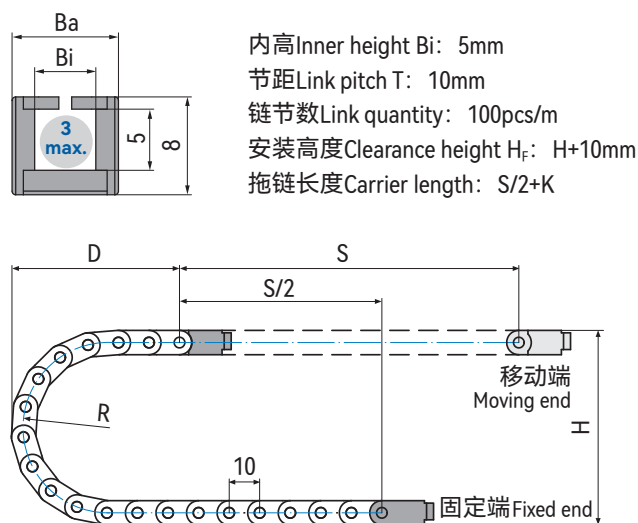
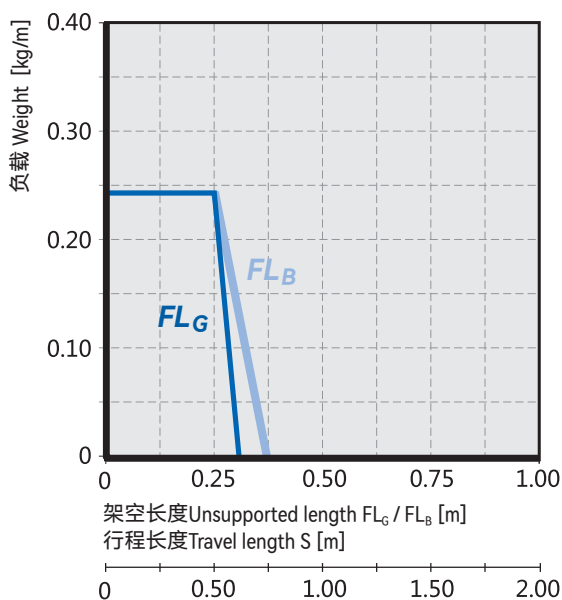

\*如果安装空间受到限制请咨询CSB®. Please consult CSB® if space is particularly restricted.

R	010	012	015	018
H	28	32	38	44
D	29	31	34	37
K	55	60	70	80

实际安装高度 The required clearance height:  $H_f=H+10$ mm (负载 Fill weight 0.1kg/m)

C11.05

DURAMOV®

www.csb-ep.com  
sales@csb-ep.com

电话: 0573 84186133/84185527  
Tel: 0086 573 84187009

## 拖链接头尺寸 Mounting bracket dimensions

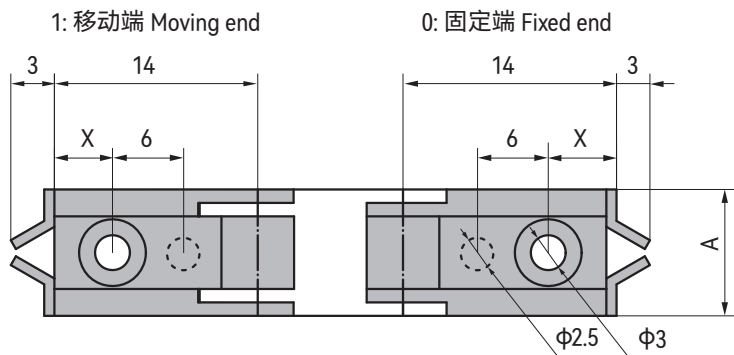

产品编码 Part No.:

**C11.05.05.01.P**

- P: 摆动设计 Pivoting
- L: 固定设计 Locking
- 固定端+移动端  
Fixed end + Moving end
- 拖链内宽 Inner width
- 拖链内高 Inner height
- 拖链系列 Carrier series

产品编码 (固定) Part No. Locking	产品编码 (摆动) Part No. Pivoting	拖链内宽 Inner width Bi [mm]	A [mm]	X [mm]
C11.05.05.01.L	C11.05.05.01.P	05	8.7	4
C11.05.07.01.L	C11.05.07.01.P	07	10.7	4
C11.05.10.01.L	C11.05.10.01.P	10	13.7	4

\*根据要求提供 Available upon request

## 接头安装方式 Mounting bracket installation optional

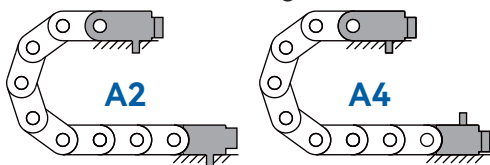

### C11.05.Bi.01.P

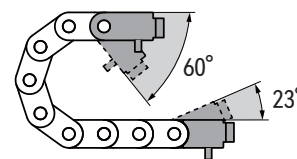

\*C11.05拖链接头安装方式示意图 Possible installation configurations

\*A2/A4订购预装配拖链请注明安装方式 Please indicate installation code for pre-assembled carriers

\*推荐架空长行程拖行应用

For unsupported and gliding applications

## 技术参数 Installation dimensions

	架空长度 Unsupported length	≤ 0.3m	速度/加速度 Speed / acceleration FL <sub>G</sub>	≤ 3 [m/s] / 8 [m/s <sup>2</sup> ]
	滑行距离 Sliding length	不适用 Inapplicable	速度/加速度 Speed / acceleration FL <sub>B</sub>	≤ 2 [m/s] / 4 [m/s <sup>2</sup> ]
	竖直悬挂 Vertical hanging	≤ 5m	滑行速度/加速度 Sliding speed / acceleration	不适用 Inapplicable
	垂直站立 Vertical standing	≤ 0.5m	允许温度 Permitted temperature	-40°C ~120°C
	侧向架空 Side-unsupported length	≤ 0.5m	阻燃等级 Flammability Class	UL94 V2

## 预装拖链订购编码 Order code for pre-assembled cable carriers

拖链本体 Body					选配 Optional
<b>C11.05.05.010.020.</b>					<b>A2L</b>
拖链系列 Carrier series	内高 Inner height	内宽 Inner width	弯曲半径 Bend radius	链节数量 Link quantity	接头与安装形式 Mounting bracket & installation type

# DURAMOV® Plastic Cable Carriers

## DURAMOV® 塑料电缆拖链

### C11.07 易填充微型电缆拖链 Micro cable carriers, open design and cable filled quickly



C11.07

DURAMOV®

#### 标准尺寸 Standard dimensions

产品编码 Part No.	内宽 Bi	外宽 Ba	内高 Hi	外高 Ha	弯曲半径 R					重量
	Inner width [mm]	Outer width [mm]	Inner height [mm]	Outer height [mm]	Bend radius [mm]					Weight [kg/m]
C11.07.07	7	12	7	10	015	018	028	038	048	0.07
C11.07.10	10	15	7	10	015	018	028	038	048	0.08
C11.07.16	16	21	7	10	015	018	028	038	048	0.09
C11.07.20	20	25	7	10	015	018	028	038	048	0.10
C11.07.30	30	35	7	10	015	018	028	038	048	0.11

\*根据要求提供 Available upon request

#### 安装尺寸 Installation dimensions

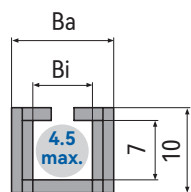
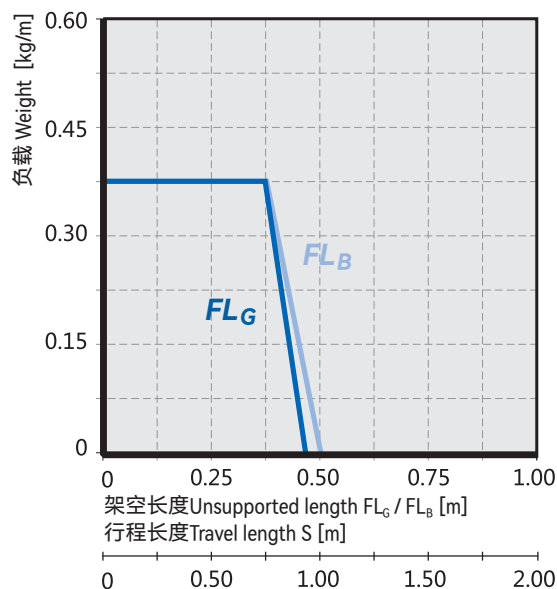

内高 Inner height Bi: 7mm  
 节距 Link pitch T: 16.7mm  
 链节数 Link quantity: 60pcs/m  
 安装高度 Clearance height H<sub>c</sub>: H+10mm  
 拖链长度 Carrier length: S/2+K

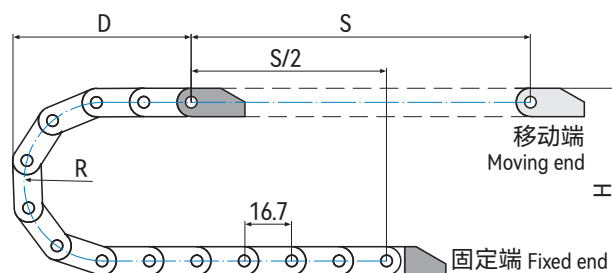

\*如果安装空间受到限制请咨询CSB®. Please consult CSB® if space is particularly restricted.

R	015	018	028	038	048
H	40	46	66	86	106
D	45	48	58	68	78
K	85	90	125	155	185

实际安装高度 The required clearance height: H<sub>c</sub>=H+10mm (负载 Fill weight 0.1kg/m)

www.csb-ep.com  
sales@csb-ep.com

电话: 0573 84186133/84185527  
Tel: 0086 573 84187009

## 拖链接头尺寸 Mounting bracket dimensions

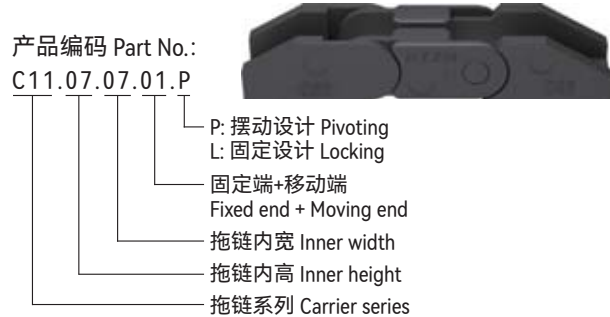
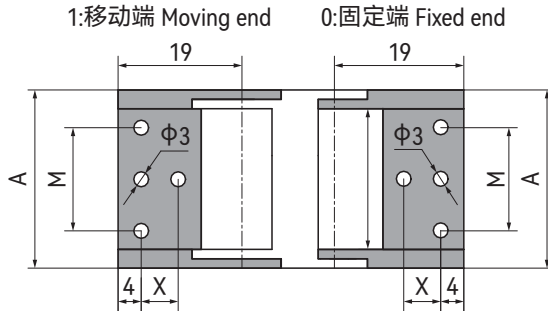

产品编码 (固定) Part No. Locking	产品编码 (摆动) Part No. Pivoting	拖链内宽 Inner width Bi [mm]	A [mm]	X [mm]	M [mm]
C11.07.07.01.L	C11.07.07.01.P	07	12	8	/
C11.07.10.01.L	C11.07.10.01.P	10	15	8	/
C11.07.16.01.L	C11.07.16.01.P	16	21	8	/
C11.07.20.01.L	C11.07.20.01.P	20	25	8	/
C11.07.30.01.L	C11.07.30.01.P	30	35	/	22

\*根据要求提供 Available upon request

### 接头安装方式 Mounting bracket installation optional

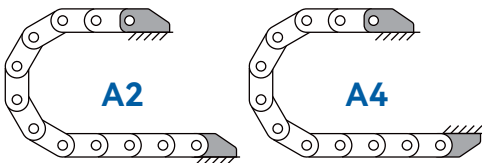

### C11.07.Bi.01.P

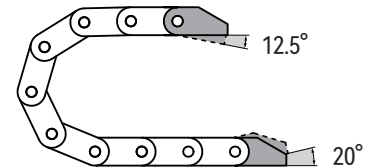

\*C11.07拖链接头安装方式示意图 Possible installation configurations

\*A2/A4订购预装配拖链请注明安装方式 Please indicate installation code for pre-assembled carriers

\*推荐架空长行程拖行应用

For unsupported and gliding applications

## 技术参数 Installation dimensions

	架空长度 Unsupported length	≤ 0.5m	速度/加速度 Speed / acceleration FL <sub>C</sub>	≤ 3 [m/s] / 8 [m/s <sup>2</sup> ]
	滑行距离 Sliding length	不适用 Inapplicable	速度/加速度 Speed / acceleration FL <sub>B</sub>	≤ 2 [m/s] / 4 [m/s <sup>2</sup> ]
	竖直悬挂 Vertical hanging	≤ 5m	滑行速度/加速度 Sliding speed / acceleration	不适用 Inapplicable
	垂直站立 Vertical standing	≤ 0.5m	允许温度 Permitted temperature	-40°C ~120°C
	侧向架空 Side-unsupported length	≤ 0.5m	阻燃等级 Flammability Class	UL94 V2

## 预装拖链订购编码 Order code for pre-assembled cable carriers

拖链本体 Body					选配 Optional
<b>C11 . 07 . 07 . 015 . 020 .</b>					<b>A2L</b>
拖链系列 Carrier series	内高 Inner height	内宽 Inner width	弯曲半径 Bend radius	链节数量 Link quantity	接头与安装形式 Mounting bracket & installation type

# DURAMOV® Plastic Cable Carriers

## DURAMOV® 塑料电缆拖链

### C11.10 易填充微型电缆拖链 Micro cable carriers, open design and cable filled quickly



#### 标准尺寸 Standard dimensions

产品编码 Part No.	内宽 Bi Inner width [mm]	外宽 Ba Outer width [mm]	内高 Hi Inner height [mm]	外高 Ha Outer height [mm]	弯曲半径 R Bend radius [mm]			重量 Weight [kg/m]
C11.10.10	10	16.5	10	15	018	028	038	0.07
C11.10.16	16	22.5	10	15	018	028	038	0.08
C11.10.20	20	26.5	10	15	018	028	038	0.09

\*根据要求提供 Available upon request

#### 安装尺寸 Installation dimensions

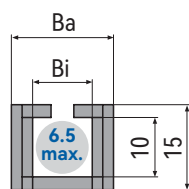
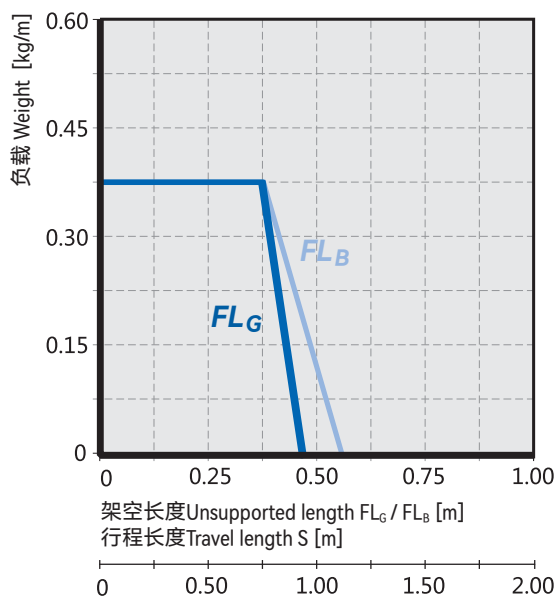

内高 Inner height Bi: 10mm  
 节距 Link pitch T: 20mm  
 链节数 Link quantity: 50pcs/m  
 安装高度 Clearance height H<sub>f</sub>: H+10mm  
 拖链长度 Carrier length: S/2+K

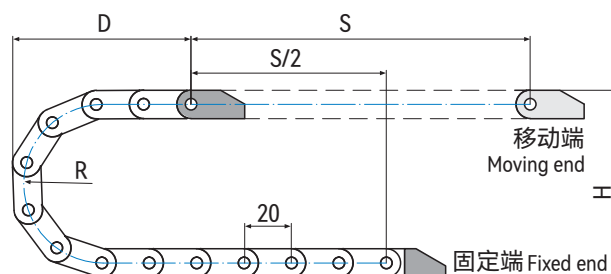

\*如果安装空间受到限制请咨询CSB®. Please consult CSB® if space is particularly restricted.

R	018	028	038
H	51	71	91
D	56	66	76
K	100	130	160

实际安装高度 The required clearance height: H<sub>f</sub>=H+10mm (负载 Fill weight 0.2kg/m)

C11.10

DURAMOV®

www.csb-ep.com  
sales@csb-ep.com

电话: 0573 84186133/84185527  
Tel: 0086 573 84187009



## 拖链接头尺寸 Mounting bracket dimensions

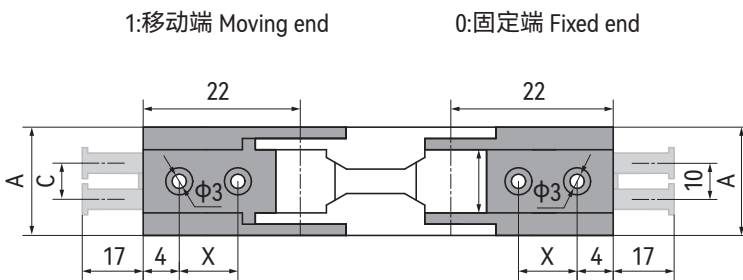

产品编码 Part No.:

**C11.10.16.01.P.TP**

- 带梳状板 With tiwrap plates
- P: 摆动设计 Pivoting
- L: 固定设计 Locking
- 固定端+移动端 Fixed end + Moving end
- 拖链内宽 Inner width
- 拖链内高 Inner height
- 拖链系列 Carrier series

无梳状板接头编码 Without tiwrap plates (固定 Locking)	带梳状板接头编码 With tiwrap plates (固定 Locking)	无梳状板接头编码 Without tiwrap plates (摆动 Pivoting)	带梳状板接头编码 With tiwrap plates (摆动 Pivoting)	拖链内宽 Inner width Bi [mm]	A [mm]	X [mm]	C [mm]	齿数 Number of teeth [pcs]
C11.10.10.01.L	/	C11.10.10.01.P	/	10	16.5	8	/	/
C11.10.16.01.L	C11.10.16.01.LTP	C11.10.16.01.P	C11.10.16.01.PTP	16	22.5	8	10	2
C11.10.20.01.L	C11.10.20.01.LTP	C11.10.20.01.P	C11.10.20.01.PTP	20	26.5	8	10	2

\*根据要求提供 Available upon request

### 接头安装方式 Mounting bracket installation optional

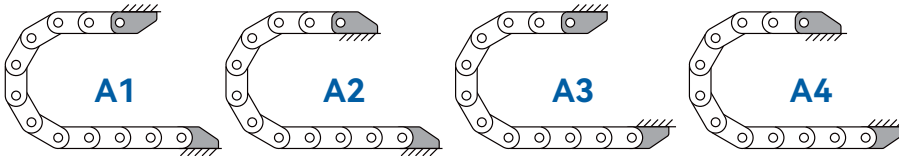
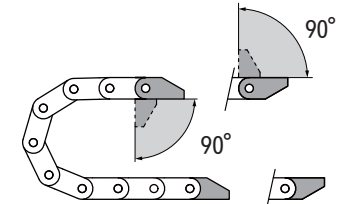
**C11.10.Bi.01.P**

\*C11.10拖链接头安装方式示意图 Possible installation configurations

\*A1|A2|A3|A4订购预装配拖链请注明安装方式 Please indicate installation code for pre-assembled carriers

\*推荐架空长行程拖行应用

For unsupported and gliding applications

### 技术参数 Installation dimensions

	架空长度 Unsupported length	≤ 0.5m	速度/加速度 Speed / acceleration FL <sub>C</sub>	≤ 3 [m/s] / 8 [m/s <sup>2</sup> ]
	滑行距离 Sliding length	不适用 Inapplicable	速度/加速度 Speed / acceleration FL <sub>B</sub>	≤ 2 [m/s] / 4 [m/s <sup>2</sup> ]
	竖直悬挂 Vertical hanging	≤ 5m	滑行速度/加速度 Sliding speed / acceleration	不适用 Inapplicable
	垂直站立 Vertical standing	≤ 0.5m	允许温度 Permitted temperature	-40°C ~120°C
	侧向架空 Side-unsupported length	≤ 0.5m	阻燃等级 Flammability Class	UL94 V2

### 预装拖链订购编码 Order code for pre-assembled cable carriers

拖链本体 Body					选配 Optional	
<b>C11.10.10.018.020.A1L.TP</b>						
拖链系列 Carrier series	内高 Inner height	内宽 Inner width	弯曲半径 Bend radius	链节数量 Link quantity	接头与安装形式 Mounting bracket & installation type	带梳状板 With tiwrap plates